

Genius  
Training tables



LAZER EDGE

artopex®



# Colorful

Visible metal components (legs, finishing caps, cable trays and metal doors) are available in all Artopex enamel finishes.



The Genius table collection is truly multi-purpose. They are available with fixed, flip-top or height-adjustable surfaces. Whether for training, conferences, business meetings or brainstorming sessions, Genius can be reconfigured in no time at all. The tables are designed to be nested vertically with ease and for wire management as needed.

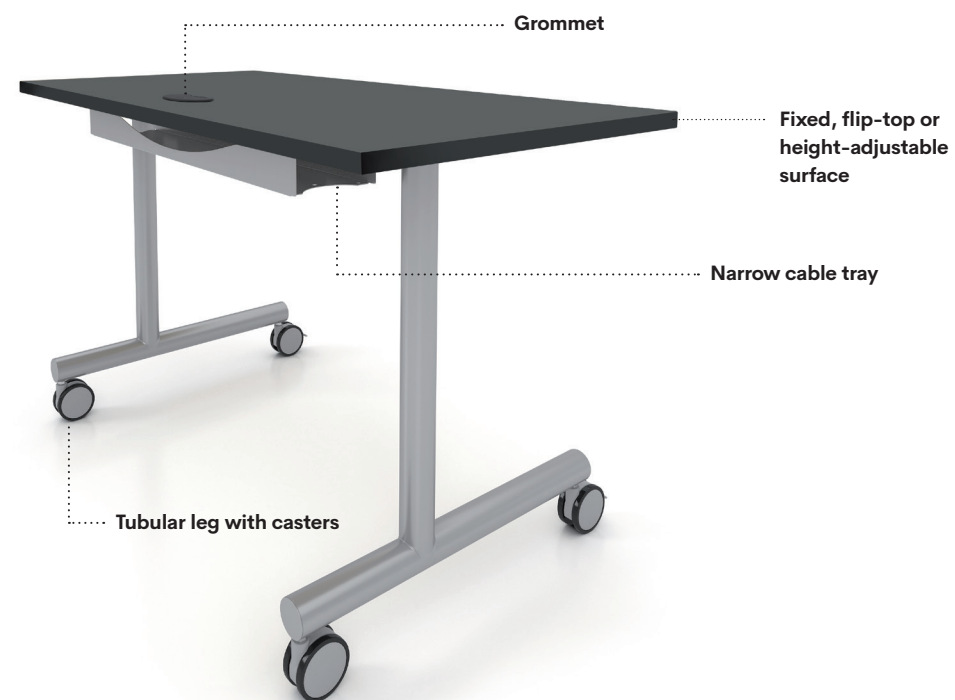

# Efficient Space Management



In storage position, flip-top tables occupy a minimum of space due to the unique interlocking leg system.

## Legs and Footings

Two distinctly different leg styles are available on the Genius table with either levelers or casters. Flip-top tables are always equipped with casters for easy storage.

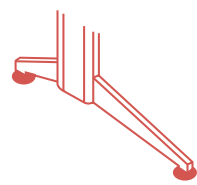

Contemporary leg with levelers

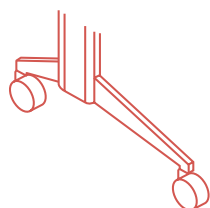

Contemporary leg with casters

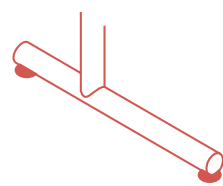

Tubular leg with levelers

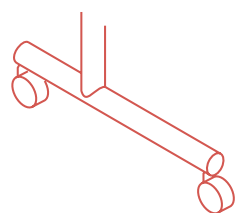

Tubular leg with casters

## Power management

### Four-circuit electrical system

- Allows for efficient wire management.
- Can be fitted with a flip access panel that also serves as a modesty panel.
- Easy access to outlets and other equipment.

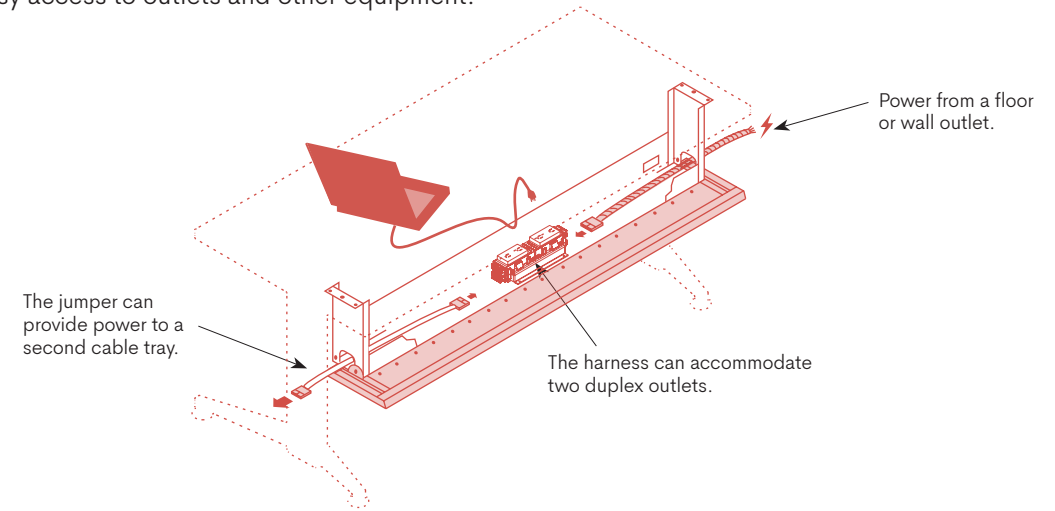

### One-circuit electrical system

- Simple installation with no need for an electrician.
- Up to 8 surface outlets (16 individual outlets) can be connected to one system.
- Easy access to outlets and other equipment.

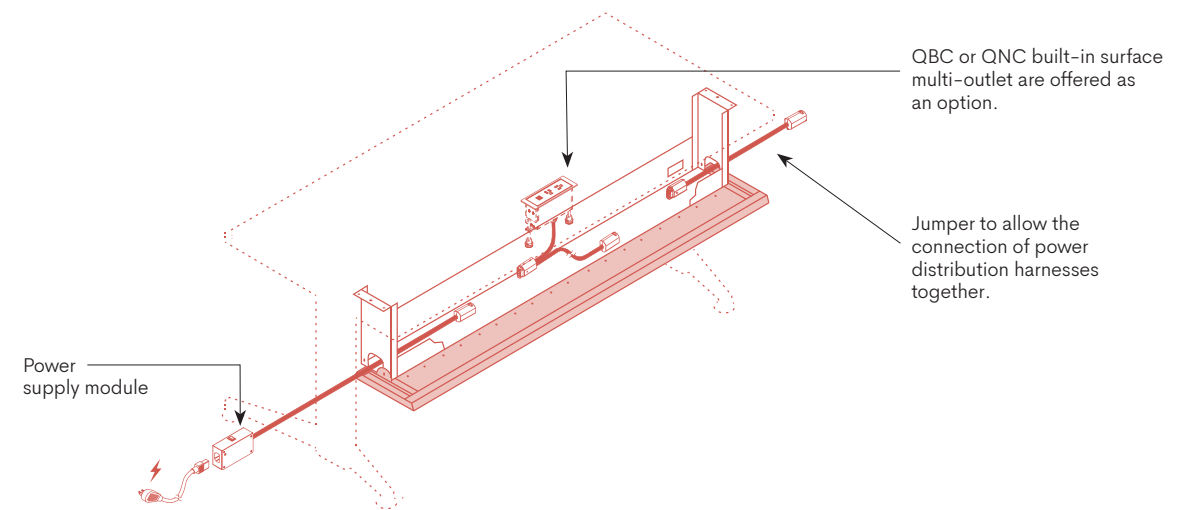

### One-circuit electrical system

Can power up to eight tables on the same circuit.

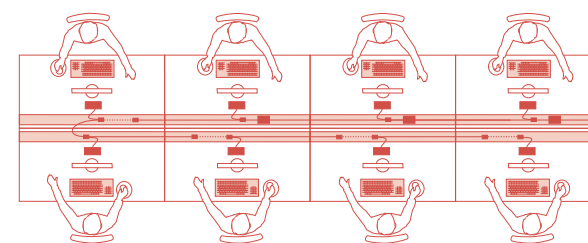

### Four-circuit electrical system

Recommended for permanent installations.

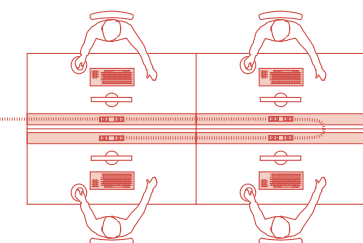

# Typical Layouts

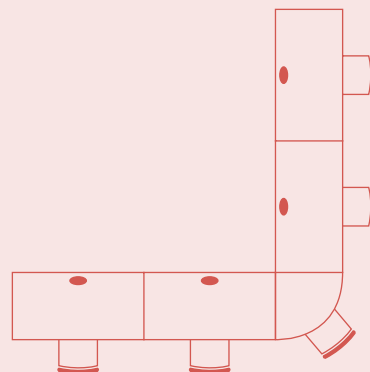
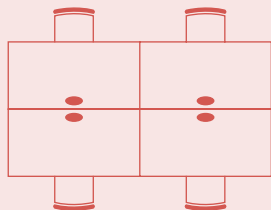
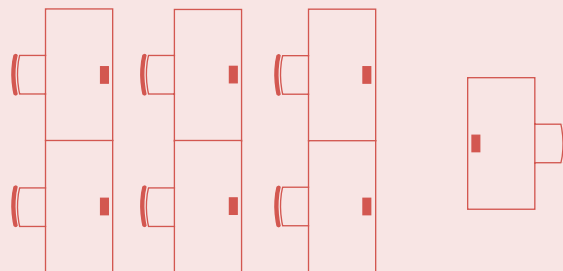
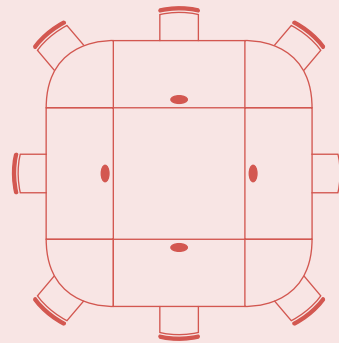
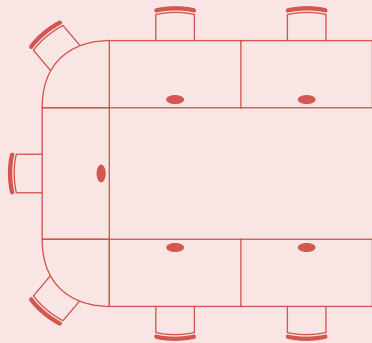

ARTOPEX  
Head office  
[artopex.com](http://artopex.com)

800 Vadnais Street  
Granby, QC, Canada J2J 1A7  
T 1 800 378 0189